

SCX SERIES

Commercial Lighting

WESTGATE
THE FUTURE IS HERE...AND IT'S QUITE BRIGHT!

SCX-8FT-80W-MCT4-D-LUV



Selection:



Custom:



Customer Name: _____

Project Name: _____

Note: _____

Type: _____

Linear Lighting can customize your desired length, look, and color temperature to be suspended, Ideal for Storage rooms, Offices Conference rooms, Retail.

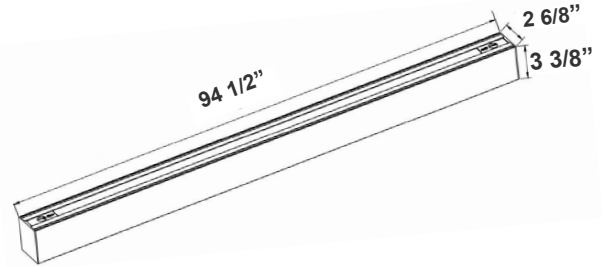

94 1/2"(L) x 2 6/8"(W) x 3 3/8"(H)

Features

- LED Superior Architectural Lights
- Seamless Linkable Linear Lighting System
- Polished Aluminum Louver Lens-Direct (DOWN) Lighting
- Lens Type: Polished Aluminum Louver Lens
- MCT: Multi Color Temperature (Selectable with Switch Inside Fixture)
- Optional Recessed & Wall Mounting Kits Available

Technical Specifications

Electrical:

- Voltage: 120-277VAC 50/60Hz
- Wattage: 80W
- Power Factor: >0.95
- Total Harmonic Distortion: ≤ 20 %

Mechanical:

- Low Profile Modern Design
- Aluminum Housing With Matte White Finish
- Custom Colors Available
- Lens Snaps into Housing
- Lens Type: Polished Aluminum Louver Lens
- Mounting Options: Surface, Suspended, Wall, Recessed
- IP Rating: IP54
- Operating Temperature: -13°F~104°F
- Adjustable Suspension Brackets Provided on Top of The Fixtures
- 5-Year Warranty

Lighting:

- Dimmable: 0~10V Dimming
- Total Lumens: 8750M/ 9224LM/ 9386LM/ 9420LM
- Color Temperatures: 3000K/3500K/4000K/5000K
- Multi-CCT(Selectable Switch Inside Fixture)
- Color Rendering Index: CRI ≥ 80
- Up Light Option Available
- 50,000 Hours Rated Life
- Beam Angle: 104.8°(H) x 100.5°(V)

Applications:

- Ideal for offices, hotels, corridors, saloons, libraries, meeting rooms, conference halls, and the best solution for modern lighting solutions
- It can be used in any indoor applications

Other Models:

• 20W | 2390LM | SCX-2FT-20W-MCT4-D-LUV • 30W | 3551LM | SCX-3FT-30W-MCT4-D-LUV • 40W | 4710LM | SCX-4FT-40W-MCT4-D-LUV • 60W | 7102LM | SCX-6FT-60W-MCT4-D-LUV



Phone: (877) 805-2252 | Fax: (877) 805-2252
www.westgatefmg.com | www.westgatecontrols.co



WG-Z8-ZB-22

Photometrics: SCX-8FT-MCT4-D-LUV

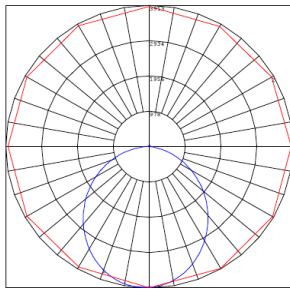
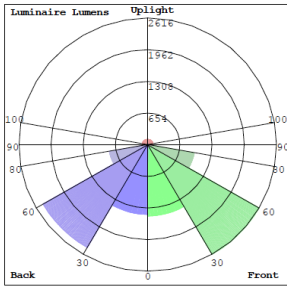

BUD Rating: B3-U3-G2

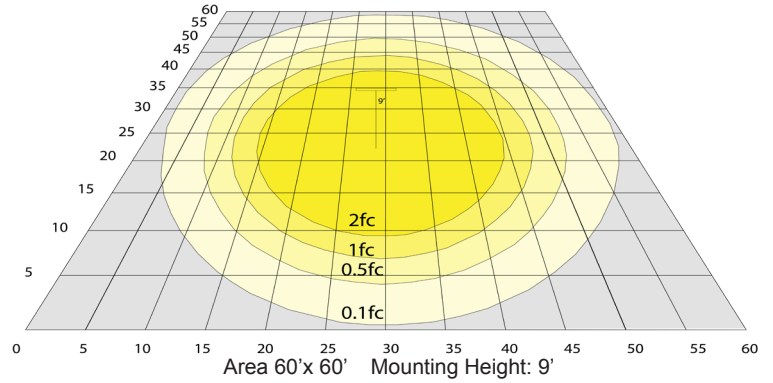

Other Views:

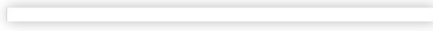

Side View



Front View

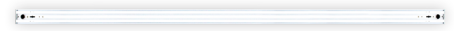

Back View

Performance Table: SCX-8FT-MCT4-D-LUV

MODEL NO.	Wattage	Voltage	Lumens	Color Temp.	BUG Rating	LPW
SCX-8FT-80W-MCT4-D-LUV	80W	120~277V	8750LM	3000K	B3-U3-G2	109
			9224LM	3500K		115
			9386LM	4000K		117
			9420LM	5000K		118

Sample Ordering

Model	Size	Wattage	Color Temp.	Feature	Lens
SCX	8FT	80W	MCT4	D	LUV

Accessories:

- Blank = No Option For Accessories
- SCL-CS = FOR UP TO 6FT FIXTURES Adjustable 6ft 1/16" Aircraft Cable Suspension Kit with Canopy for Ceiling or T-Bar
- SCL-CS3 = FOR 8FT FIXTURES Adjustable 6ft 1/16" Aircraft Cable Suspension Kit with Canopy for Ceiling or T-Bar
- SCL-6FT-SJTW18/5 = 6ft White Cord, SJTW 18 AWG 5-Conductor (Black, White, Green + Purple & Gray for 0-10V Dimming)
- SCL-6FT-SJTW18/5-100FT = 100ft Roll of White Cord, SJTW 18 AWG 5-Conductor (Black, White, Green + Purple & Gray for 0-10V Dimming)
- SCL-6FT-SJTW18/5-100FT-BK = 100ft Roll of Black Cord, SJTW 18 AWG 5-Conductor (Black, White, Green + Purple & Gray for 0-10V Dimming)
- SCL-6FT-SJTW18/6-100FT = 100ft Roll of Black Cord, SJTW 18 AWG 6-Conductor (Black, White, Green + Purple & Gray for 0-10V Dimming + Red for Backup Inverter)
- SCL-AH = Heavy-Duty Auxiliary Hook for Up To 1/16" Aircraft Cable
- SCL-ASC-500FT = 1/16" 500 ft. Steel Aircraft Cable Suspension

* More Mounting Options Refer to page 4

Factory-Installed Options:

- Blank = No Option For Accessories
- OPT-HBC-125BS-WH = 10FT, 15A, 125V, 18/3 STR, WHT

* More Factory-Installed Options Refer to page 4

Example:

1. SCX-8FT-80W-MCT4-D-LUV

(For SCX 80W MCT4 fixture 120-277V)

2. SCX-8FT-80W-MCT4-D-LUV
OPT-HBC-125BS-WH

(For SCX 80W MCT4 fixture 120-277V)
(10FT, 15A, 125V, 18/3 STR, WHT)



SUSPENDED MOUNTING ACCESSORIES (NOT INCLUDED)



SCL-CS



SCL-CS3



SCL-6FT-SJTW18/5-100FT



SCL-6FT-SJTW18/5-100FT-BK



SCL-ASC-500FT



SCL-AH



SCL-ASC-500FT



SCL-6FT-SJTW18/5

FACTORY-INSTALLED OPTIONS:



OPT-HBC-125BS-WH

MOUNTING AND MODULES OPTIONS:

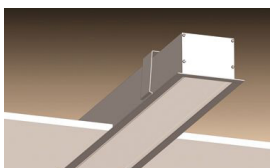

Recessed Mounted
(Flanged)



Surface Mounted



Wall Mounted



Suspended

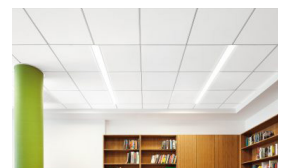

T-Bar Installation

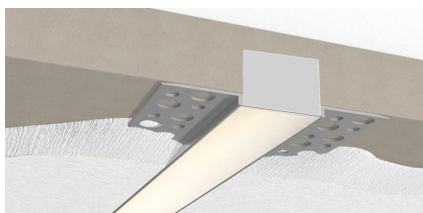

Flangless Recessed Mounted
(Mud-In)

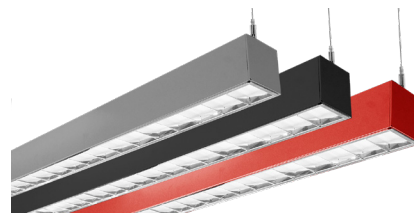

Color of Your Choice



MOUNTING OPTIONS:

FLANGLSS RECESSED INSTALLATION IN WOOD CEILING

No additional accessories required.

Make recessed preparations by installing a horizontal plank of wood on top of the wood ceiling at a recessed height of 3 3/8".

Screw and anchor kit provided with each fixture can be used to fasten the top of the fixture to the wood plank through the holes on top of the fixture.

You can also install vertical wood boards on top of the ceiling at the edge of the opening and open the fixture and put screws through the side of the fixture housing to fasten it to the wood boards.

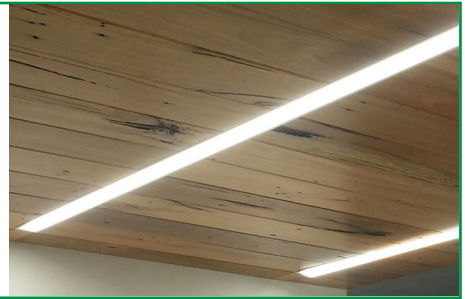

SUSPENSION ROD KITS (SET OF 2)

Model	SIZE
SCL-RS-12	12 IN
SCL-RS-18	18 IN
SCL-RS-24	24 IN
SCL-RS-36	36 IN
SCL-RS-48	48 IN

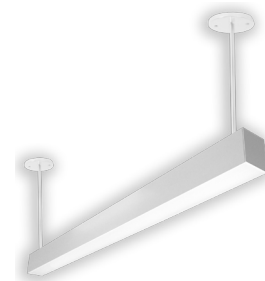

WALL MOUNTING

Model	DESCRIPTION
OPT-SCX-WM-8FT	Install this optional wall mounting brackets on the back of the fixture. Connection cables will enter the fixture through one of these wall-mounting brackets. On your purchase order, please specify the position of where your wire entry from the wall.

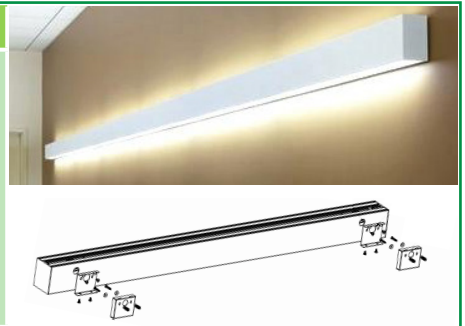

RECESSED MOUNT WITH FLANGE

Model	DESCRIPTION
OPT-SCX-FMR-8FT	Order this option and the fixture will be equipped with a 1/2" wide flange on four sides. Advanced design toggle-style brackets will also be provided, to adjust and hold the fixture against drywall or other hard ceilings from the top. When linking to another fixture or corner module, call us or send a copy of your plan along with your PO, and flanges will be removed on those ends that need to make a seamless connection.

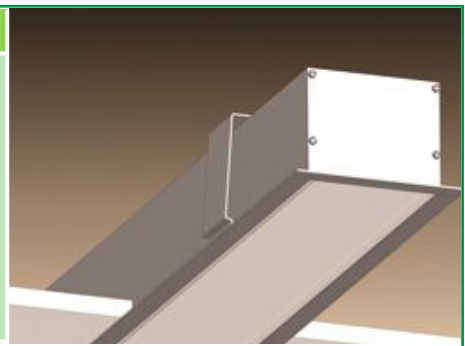

LINKING



Model	DESCRIPTION
OPT-SCX-LINKWIRING	Fixtures are equipped with pre-installed linking brackets and accessories and only need to be wired together. to receive a fixture prewired for linking, order the option below for each link to another fixture or a corner module.

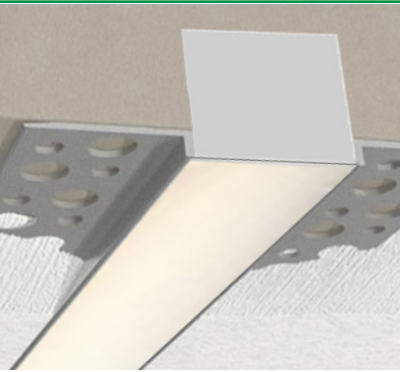

FLANGELESS RECESS MOUNT IN DRYWALL (MUD-IN)

Model	DESCRIPTION	
OPT-SCX-MIF-3FT	Order this option and the fixture will be equipped with mud-in brackets on all four sides, mounted at 1/16" from the lens surface (specify if other spacing is needed). Advanced design toggle-style brackets will also be provided, to adjust and hold the fixture against the drywall ceiling from the top. When linking to another fixture or corner fixture module call us or send a copy of your plan along with your PO and flanges will be removed on those end that needs to make a seamless connection.	

T-BAR INSTALLATION

Model	DESCRIPTION	
OPT-SCX-TBAR-8FT	Add this option and 1/2" wide flanges will be installed on the two long sides of the fixture. The two ends of the fixture will fall onto the T-bar grids and will be supported this way. The T-bar tiles on the two sides of the fixture must be cut to allow for the width of the fixture. The tile will fall onto and be supported by the flanges on both sides of the fixture. If you plan to support the fixture by the grids on three sides and tile on one side, call us or specify on your PO, and flange will be installed only on one side of the fixture. To provide safety and support from the beams above the T-bar ceiling order 10ft or 20ft aircraft suspension kits below.	
SCL-GS10	Adjustable 1/16" 10ft suspension kit with loop gripper & toggle ends hold up to 70 lbs load.	
SCL-GS20	Adjustable 1/16" 20ft suspension kit with loop gripper & toggle ends hold up to 70 lbs load.	
OPT-FWH-63 OPT-FWH-65 OPT-FWH-66	This is a 6FT 3-Wire Whip option. This is a 6FT 5-Wire Whip option. This is a 6FT 6-Wire Whip option.	

SURFACE MOUNTING

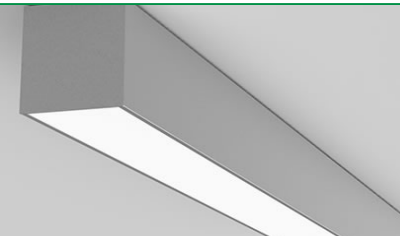
<p>No additional accessories required.</p> <p>Screw and anchor kit provided with each fixture can be used to fasten the fixture directly to the hard surface through the holes on top of the fixture.</p>	
---	---



FACTORY-INSTALLED OPTIONS:

COLOR OF YOUR CHOICE

Model	DESCRIPTION
OPT-SCX-CLR-8FT	Add this option and specify your desired color on your purchase order or provide a swatch to match. For painted flanged fixture or optional rod, mounting set please also add the relevant option below for each fixture.
OPT-SCX-CLR-FRM	This is a painted flanges option.
OPT-SCX-CLR-RODSET	This is a painted rod set option.

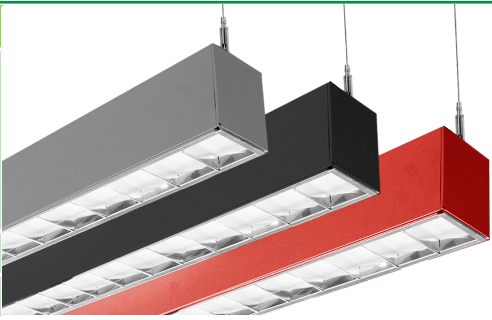

INDIRECT (UP) LIGHTING

Model	WATTS	LUMENS	COLOR TEMP	SIZE
OPT-SCX-ULM-8FT-32W-MCT4	32W	3200LM 3296LM 3360LM 3456LM	3000K 4000K 5000K 6000K	8FT
OPT-SCX-ULM-BU	Indirect (up) light with blue color			
OPT-SCX-ULM-GR	Indirect (up) light with green color			



EMERGENCY BATTERY BACKUP

Model	DESCRIPTION
OPT-EM-CM2INT	This is an option for a 90-minute backup battery installation. If you need to order this series for the fixture, please have your purchase order ready and call us or specify on the order which fixture to install this option and the test button.

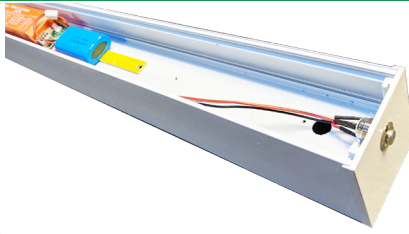

BI-LEVEL MOTION SENSOR

Model	DESCRIPTION
OPT-SCX-SEN2US	This option installs an advanced motion sensor that will turn the lights on when the area is occupied. When the area is cleared, after a preset hold time of 5 sec or more the lights are dimmed to a standby level of 30% or more. If still no motion is detected, after the standby period, the light is turned off. All setting is programmable with a remote control.
OPT-WEC-3RC	This is an optional remote control for sensor.
OPT-SEN-SCX-2MRLV-5	This is a programmable microwave Bi-Level sensor.
OPT-SEN-2US-DAYLIGHT	It is an ultrasonic Bi-Level Dimming Daylight sensor option for internal installation inside the fixture. (Remote not needed)

